

CATÉGORIE: *SIMPLE FÉM BENTJ*

ÉCOLE: *G.R.*

HEURE: *8h30*

POINTAGE: *1 MATCH 21 PTS*
SANS PROL

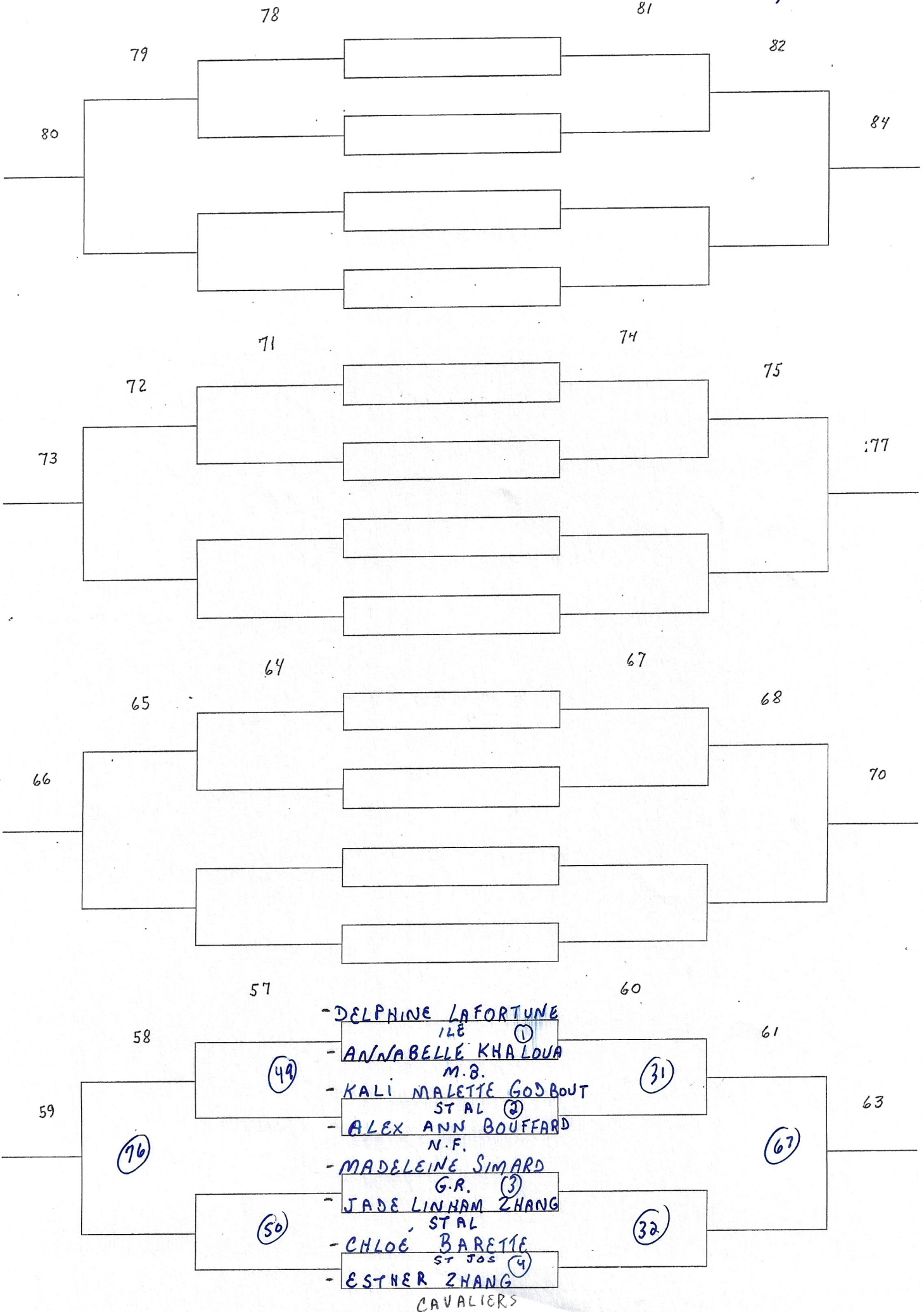

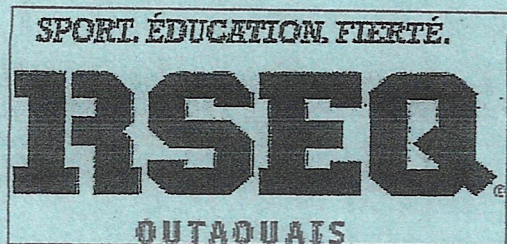

CATÉGORIE: SIMPLE FEM BEN

ÉCOLE: G. R.

HEURE: 8h30

POINTAGE: 1 MATCH 21 PTS
SANS PROL

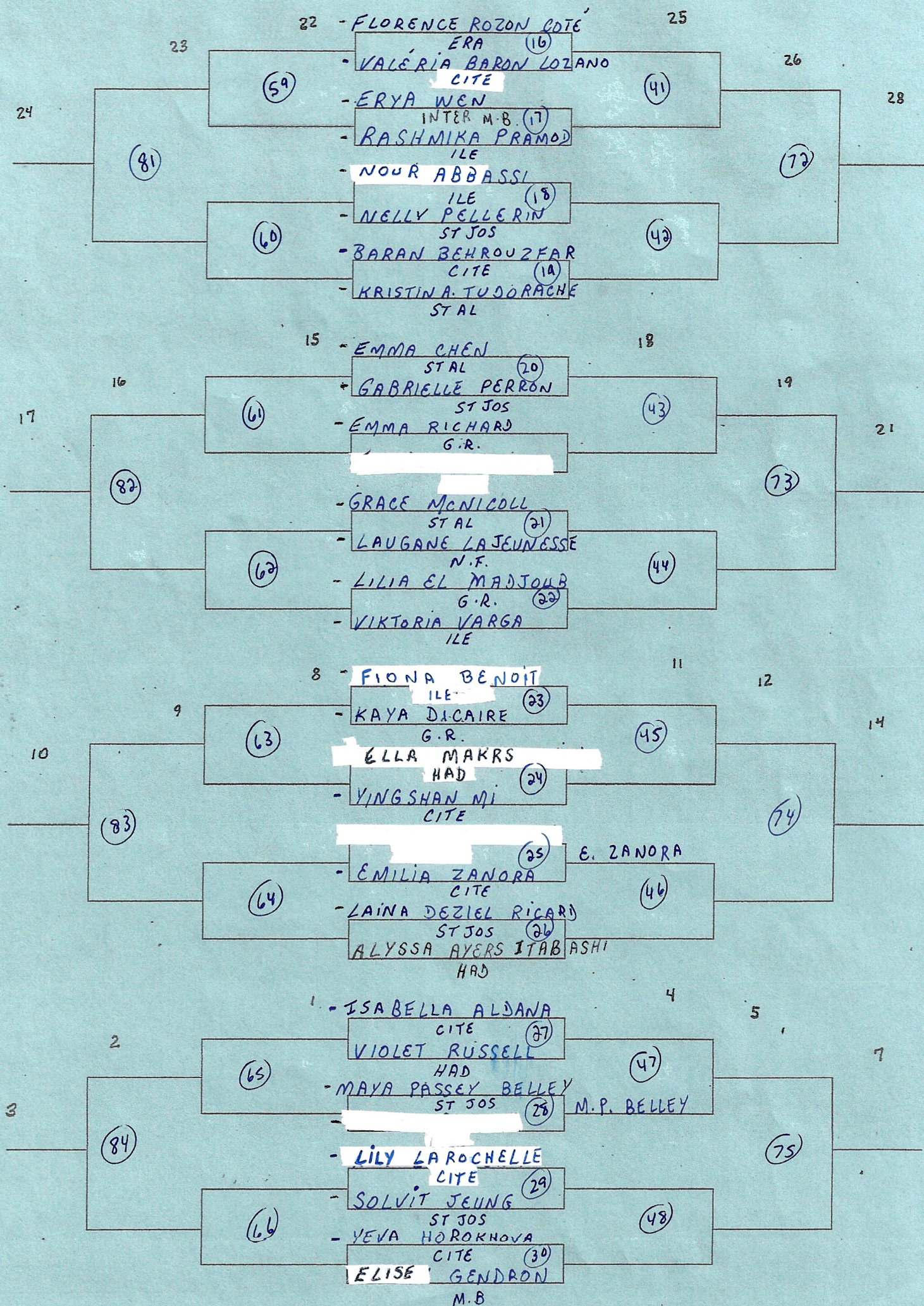

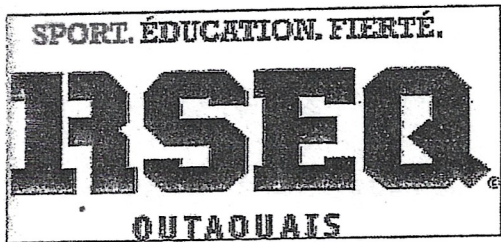

CATÉGORIE: SIMPLE FÉM BENJ

ÉCOLE: G. R.

HEURE: 8h30

POINTAGE: 1 MATCH 21 pts
SANS PROL

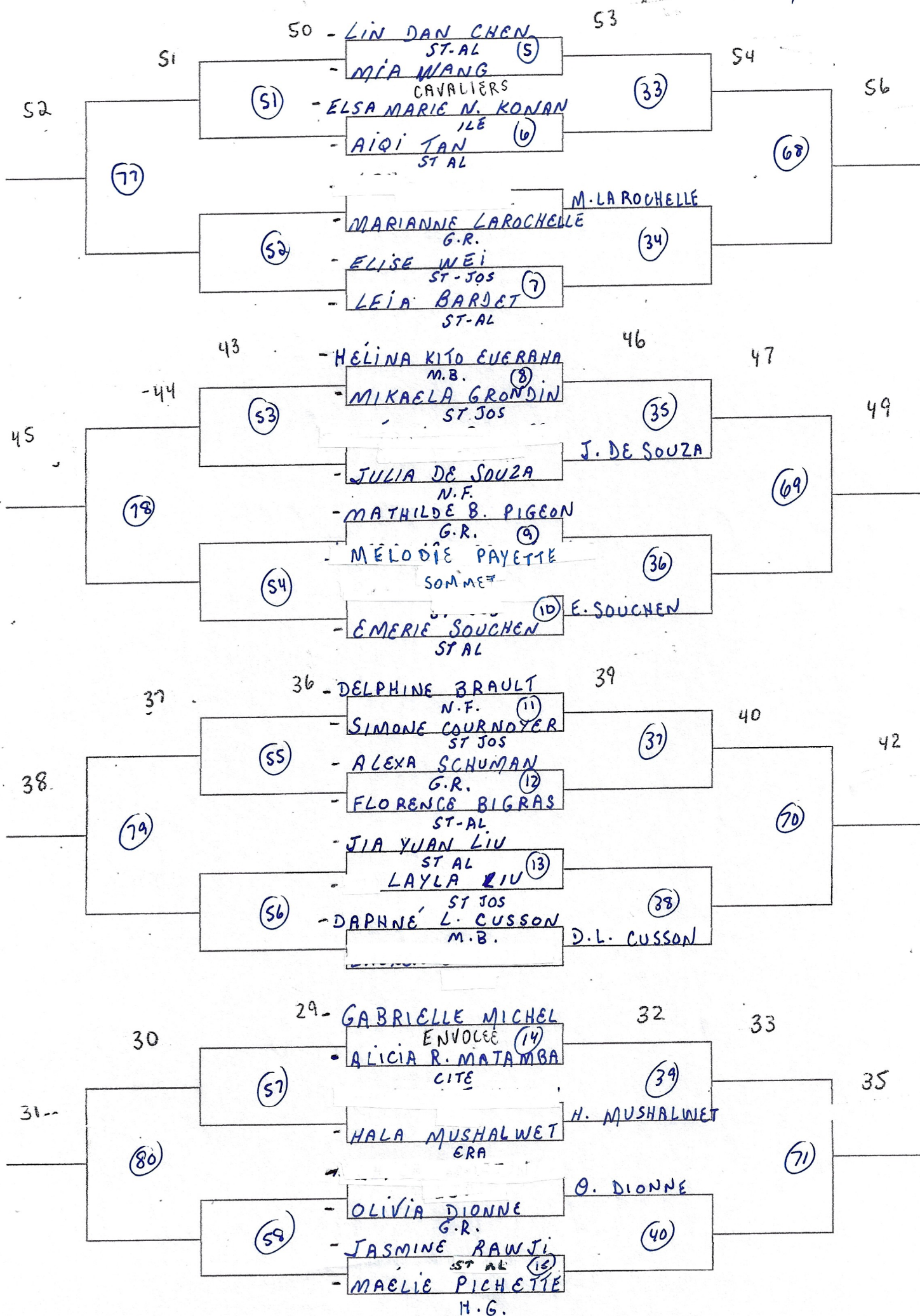

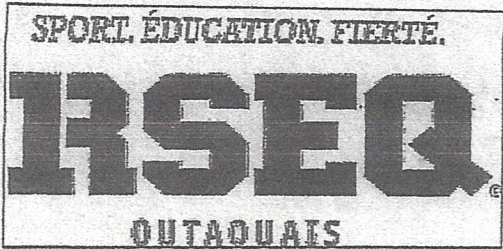

CATÉGORIE: DOUBLE FEM' BENT

ÉCOLE: G.R.

HEURE: 10h15

POINTAGE: 1 MATCH 21 pts

SANS PROL

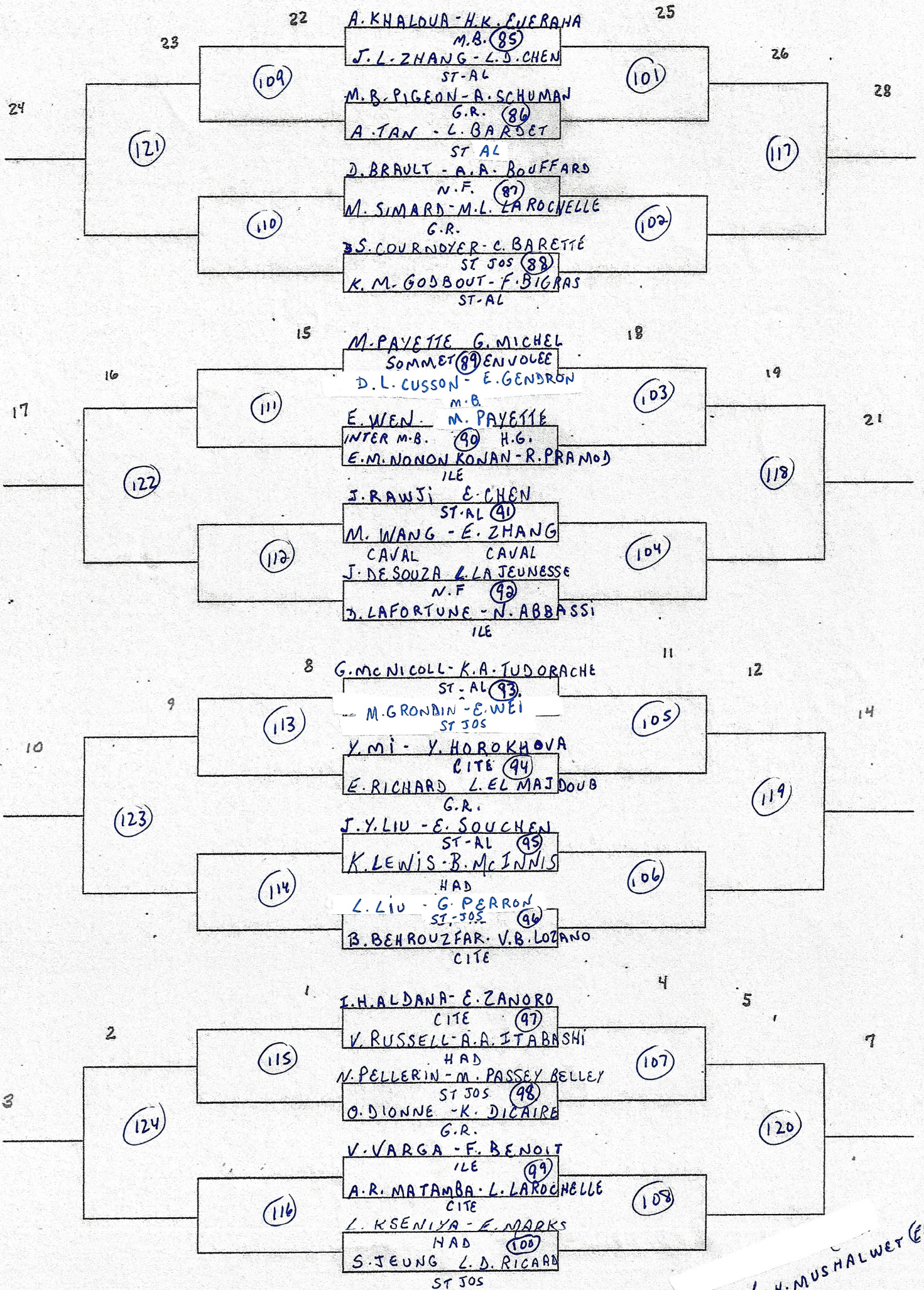

F. ROZON CÔTÉ - H. MUSHALWET (FRAB)

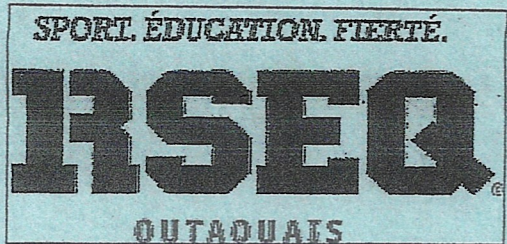

CATÉGORIE: SIMPLE FEM CAJET

ÉCOLE: G.R.

HEURE: 11 h

POINTAGE: 1 MATCH 21 PTS
SANS PROL

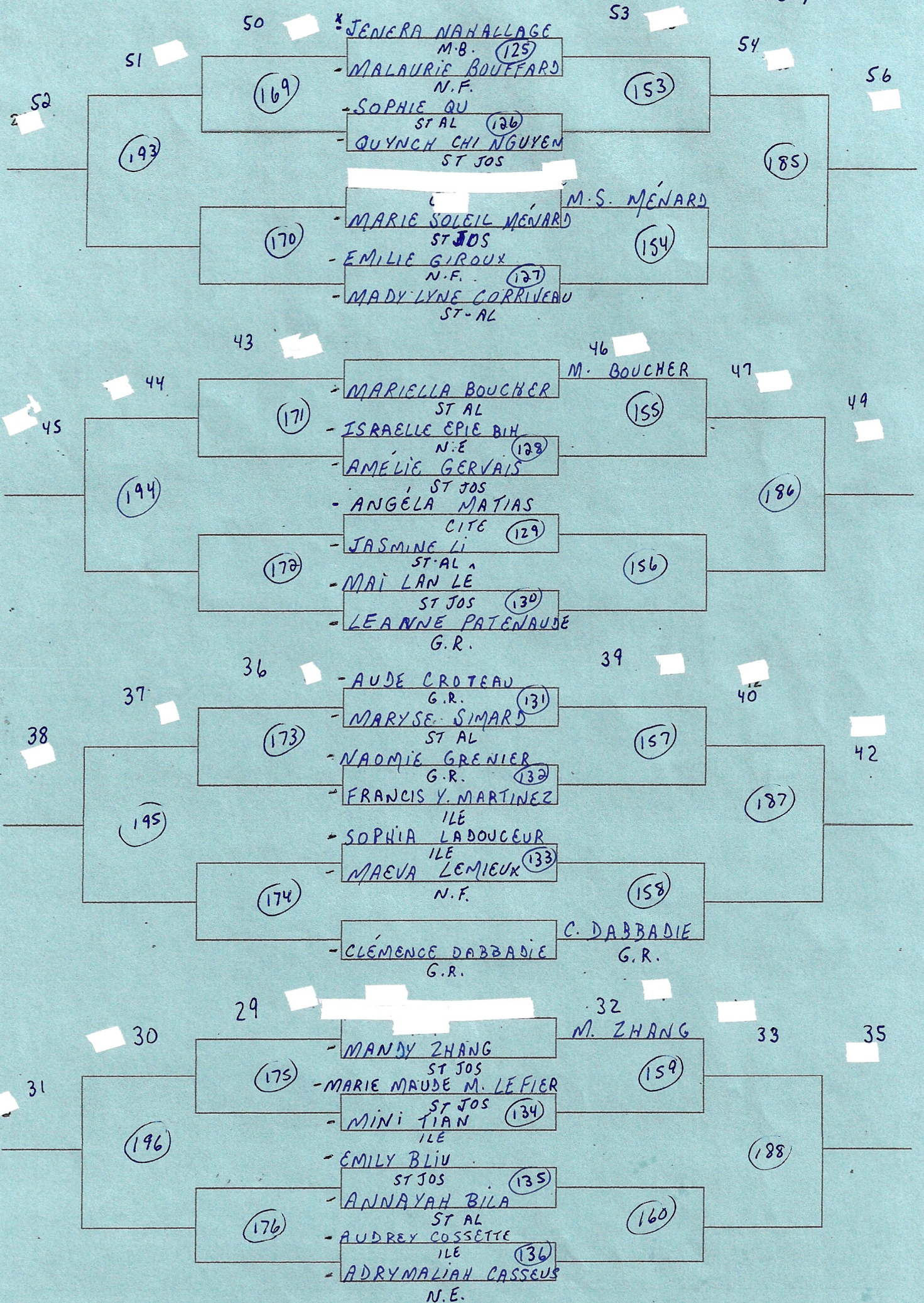

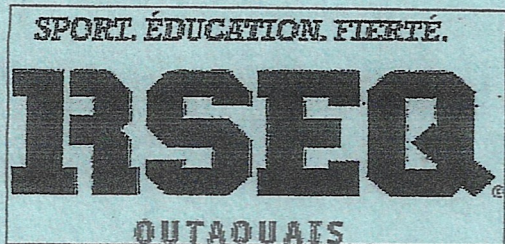

CATÉGORIE: SIMPLE FEM. CADET

ÉCOLE: G.R.

HEURE: 11h30

POINTAGE: 1 MATCH 21 pts
SANS PROL

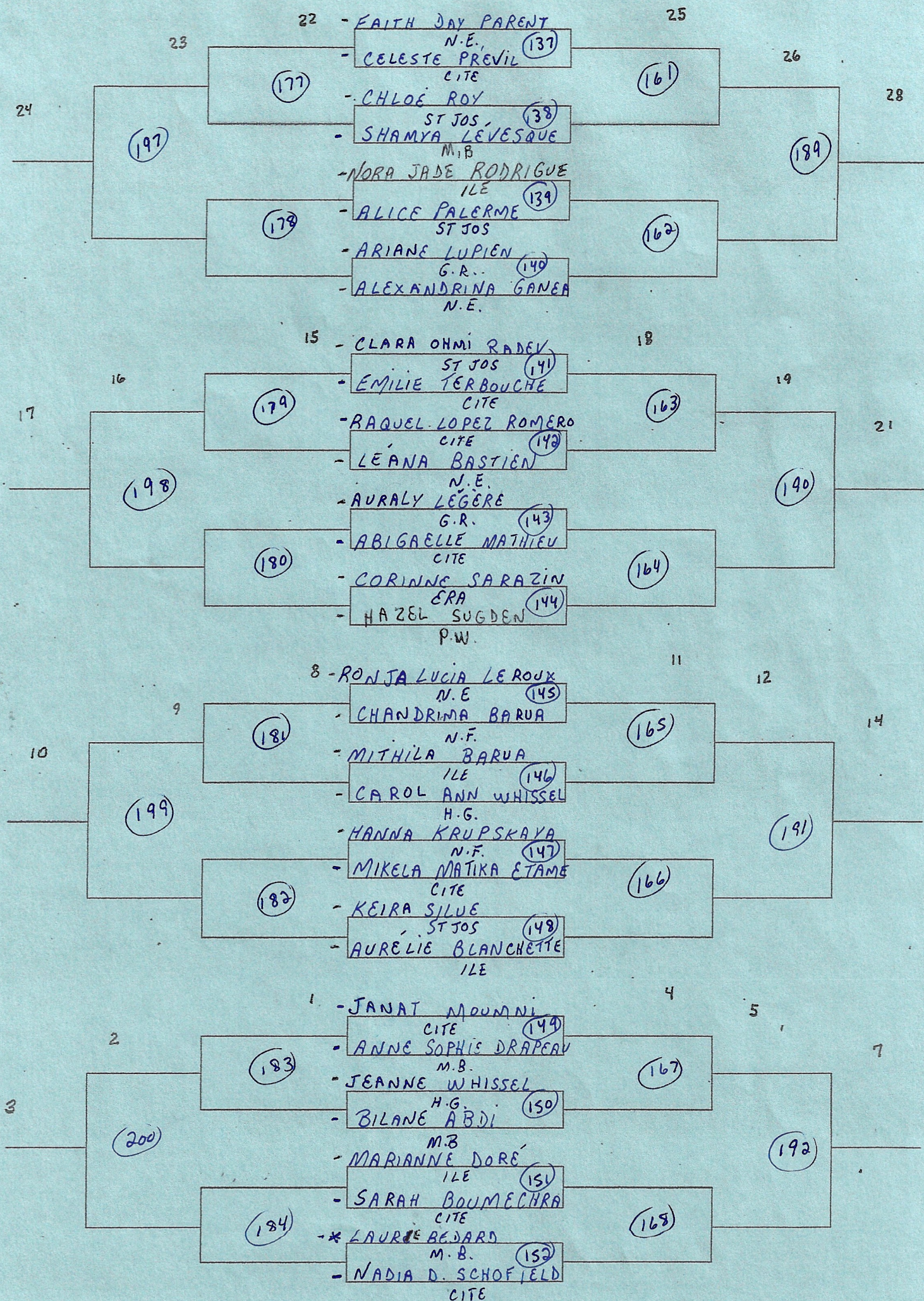

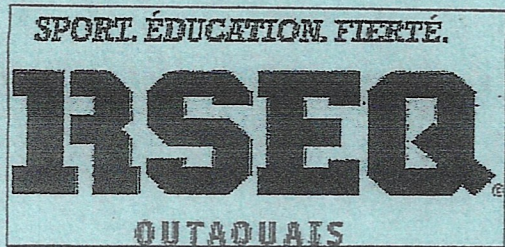

CATÉGORIE: DOUBLE FEMIN CADET

ÉCOLE: G. R.

HEURE: 13h

POINTAGE: / MATCH 21 pts
SANS PROL

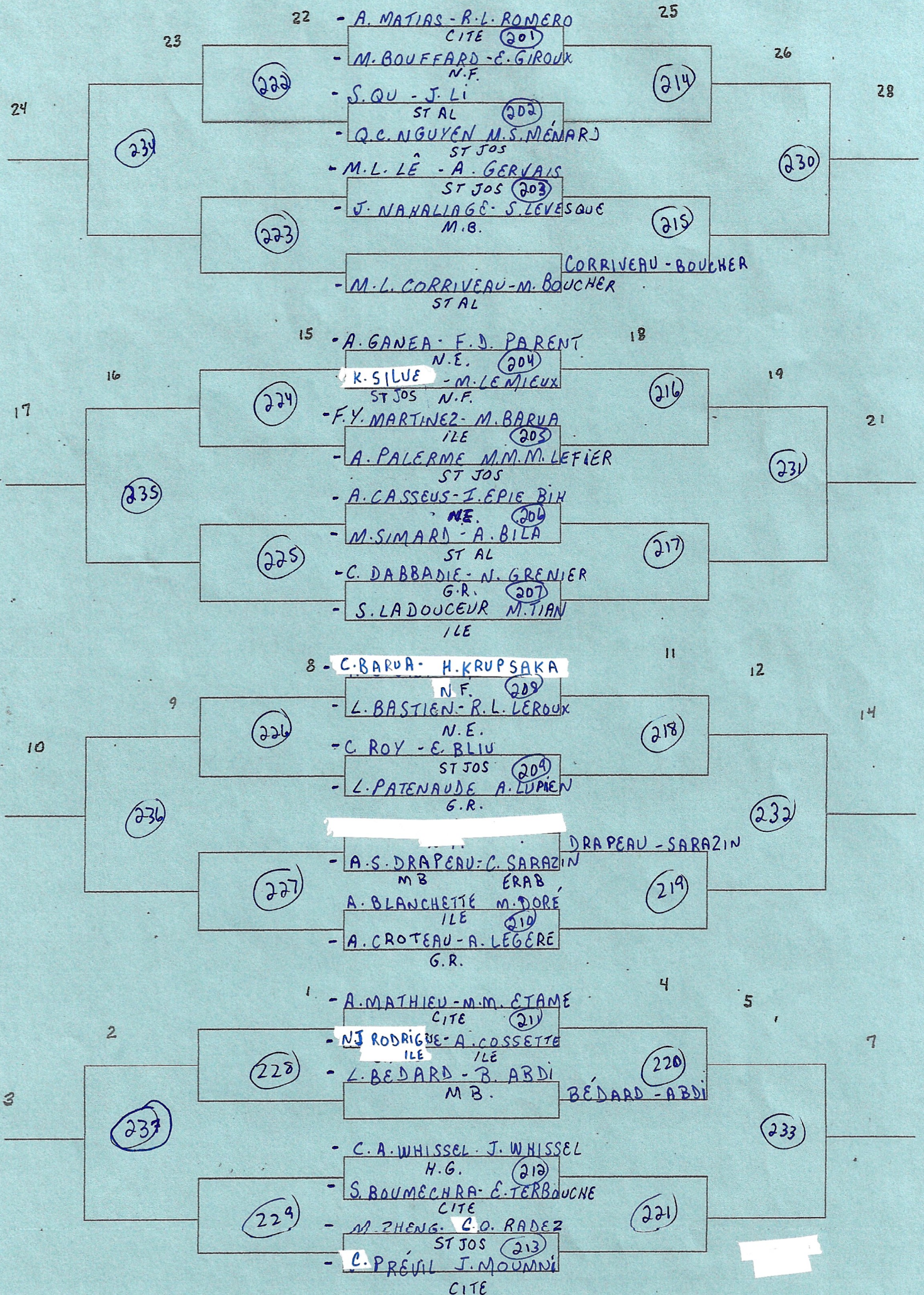

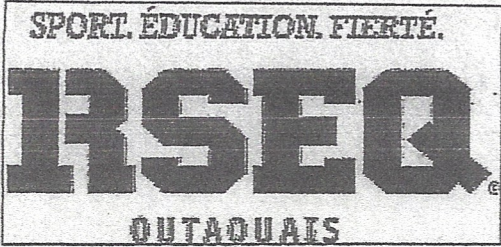

CATÉGORIE: DOUBLE MIXTE CAD

ÉCOLE: G.R.

HEURE: 14h45

POINTAGE: / MATCH 2/PTS
SANS PROL

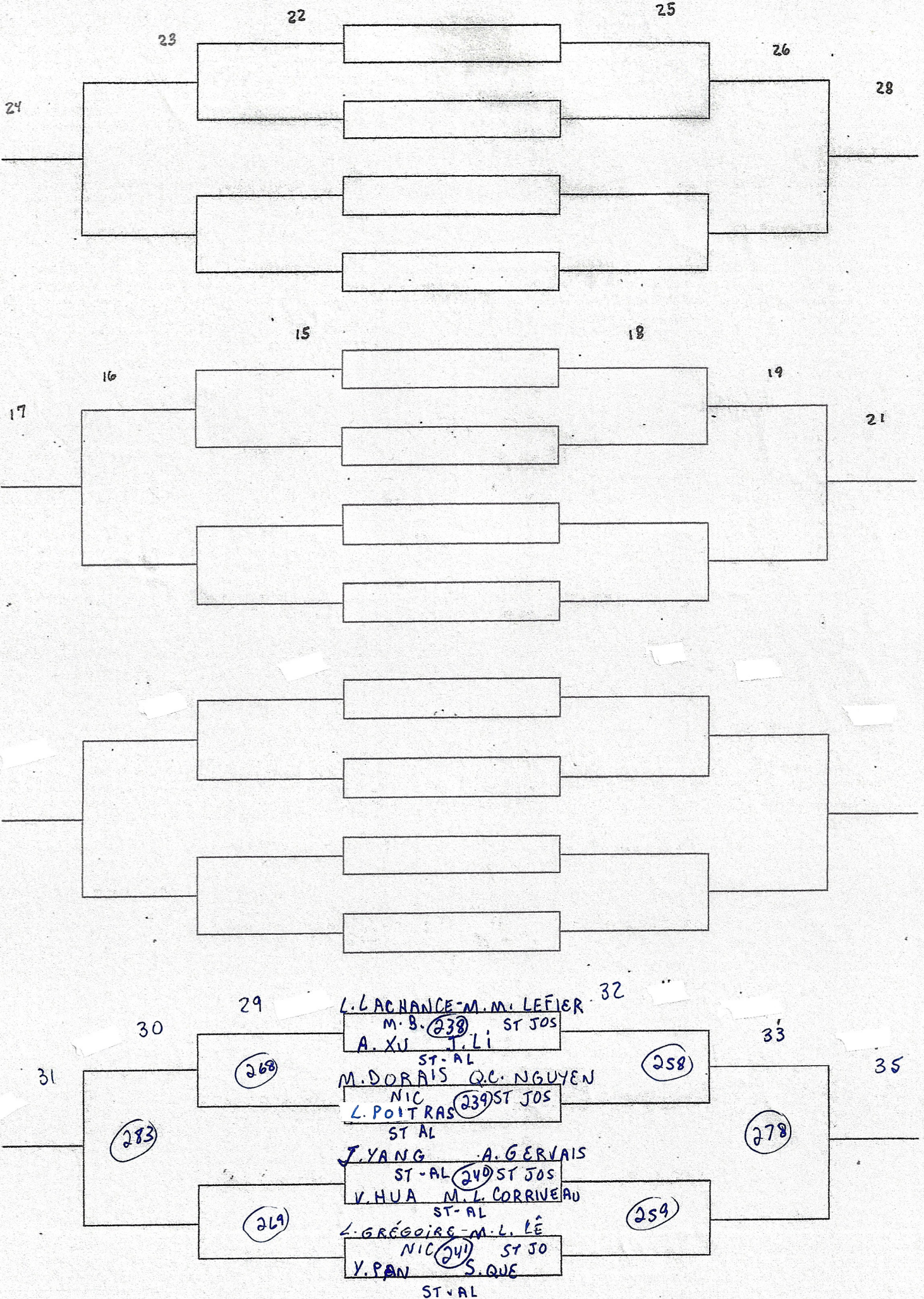

GRANDE RIVIÈRE

16 h 30

SIMPLE MASC CAJET

1 MATCH 21 PTS SANS PROL'

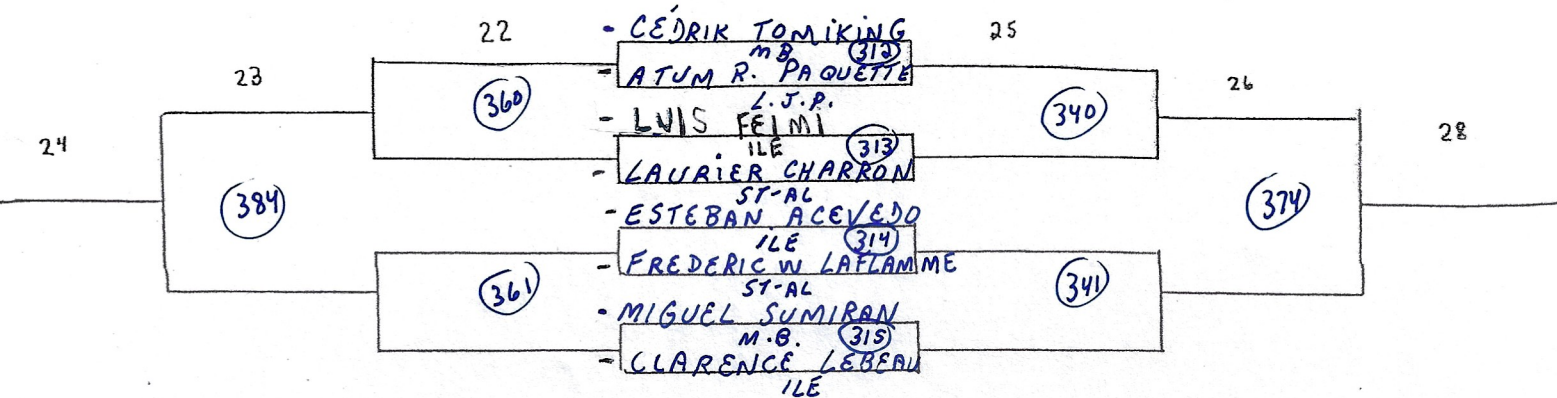
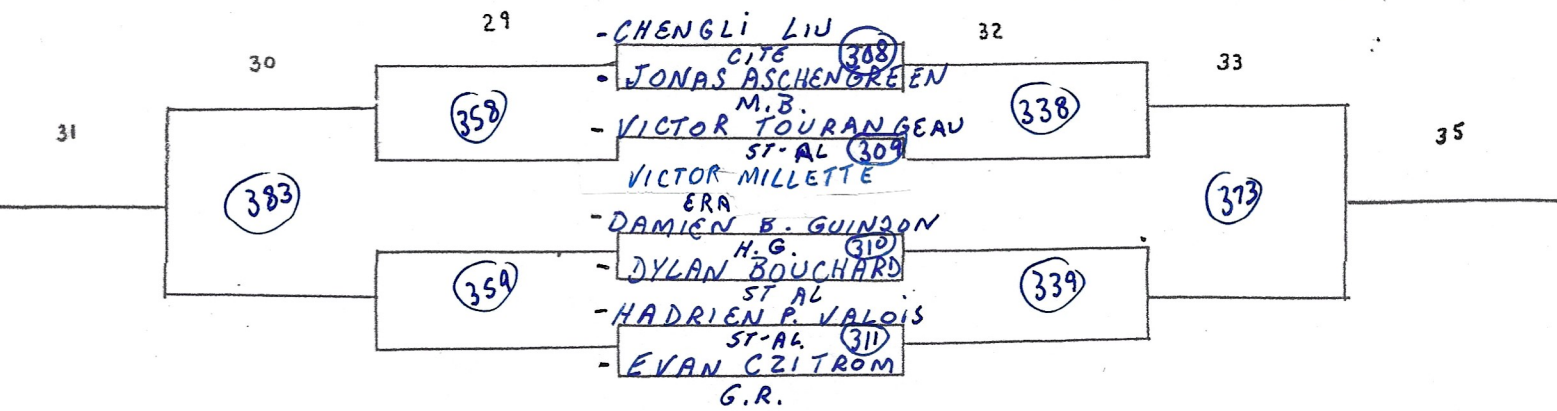

TOUS LES JOUEURS DOIVENT JOUER UN MINIMUM DE DEUX PARTIES PAR ÉPREUVE

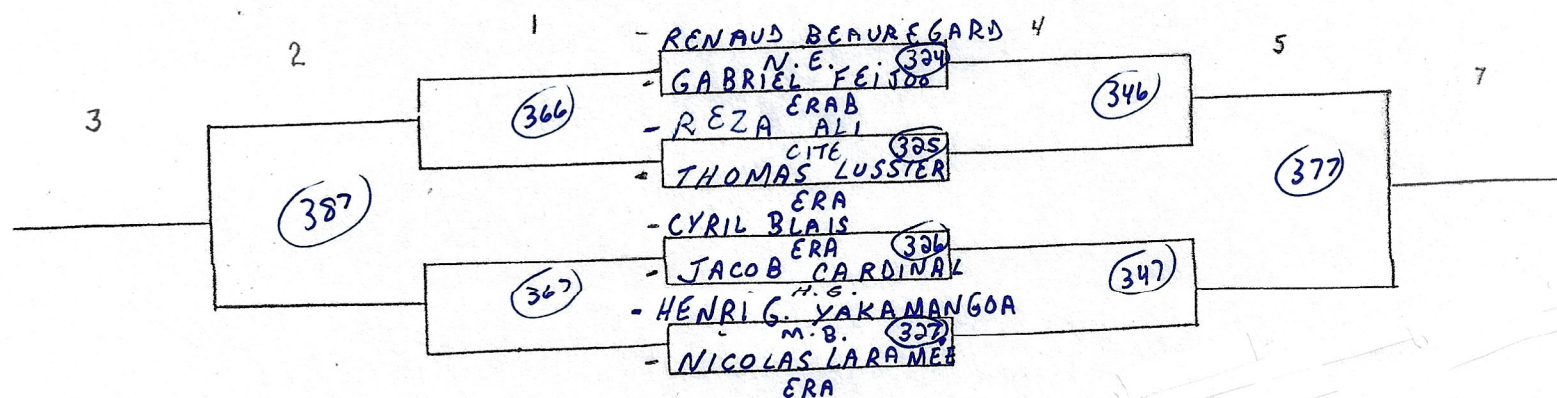
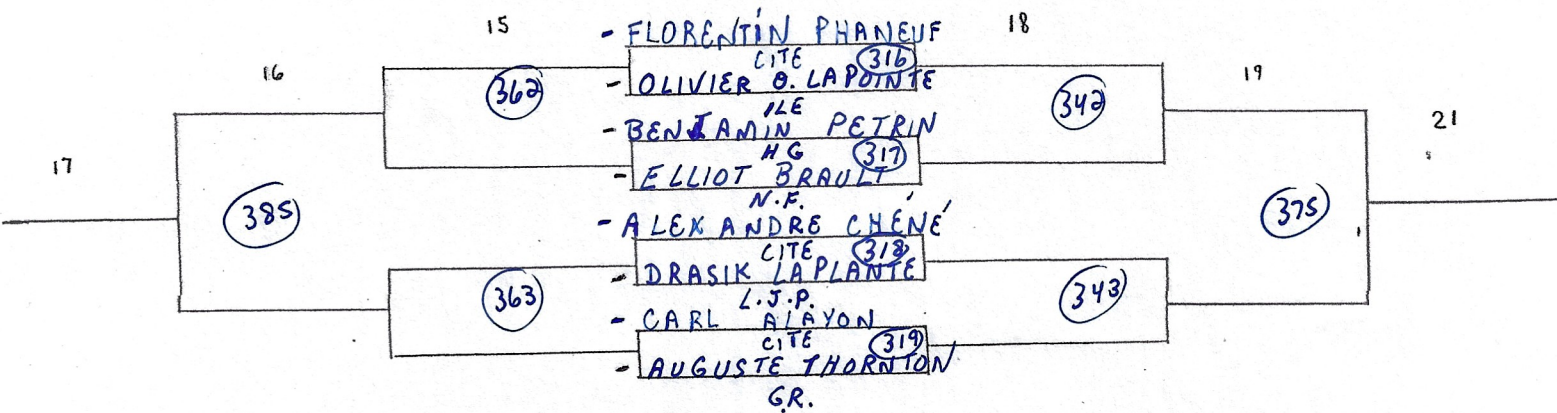

GRANDE RIVIÈRE
18 h

DOUBLE MASCULIN CAJET
1 MATCH 21 pts SANS PROL

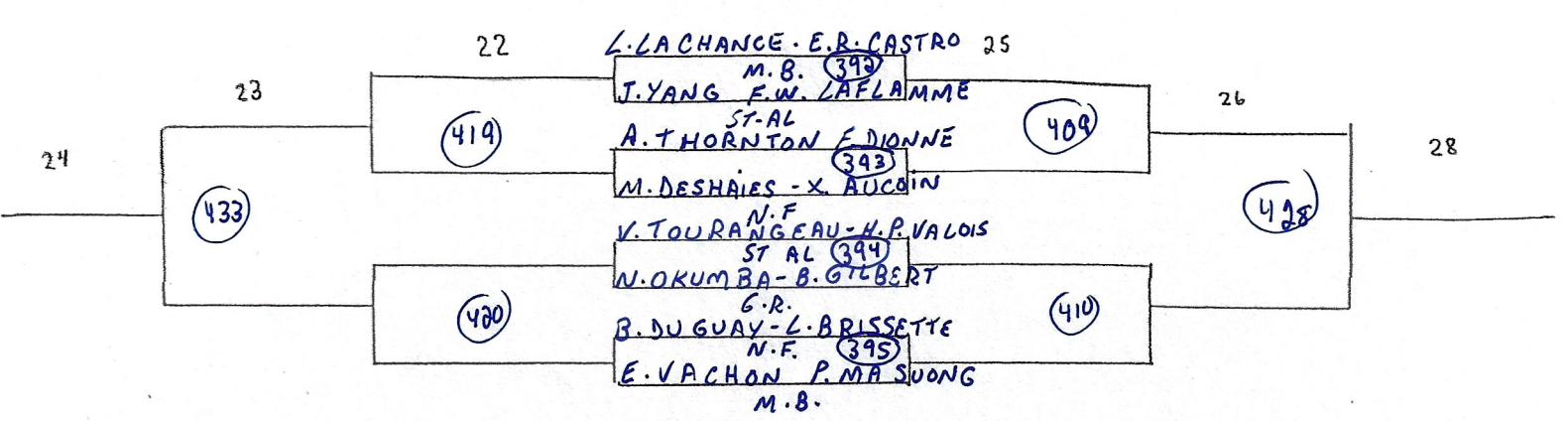
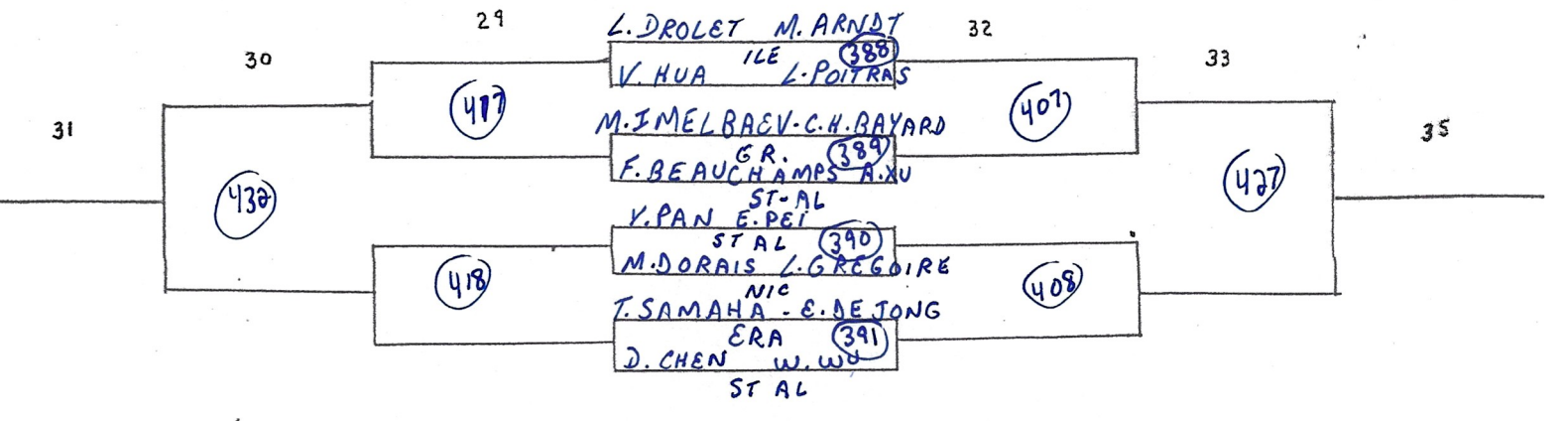

TOUS LES JOUEURS DOIVENT JOUER UN MINIMUM DE DEUX PARTIES PAR ÉPREUVE

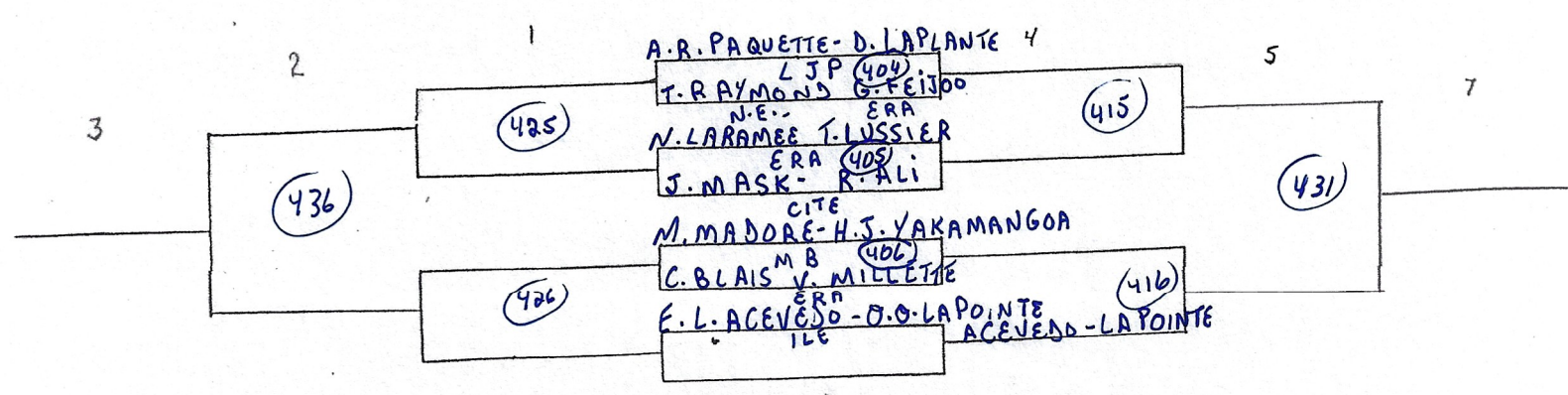
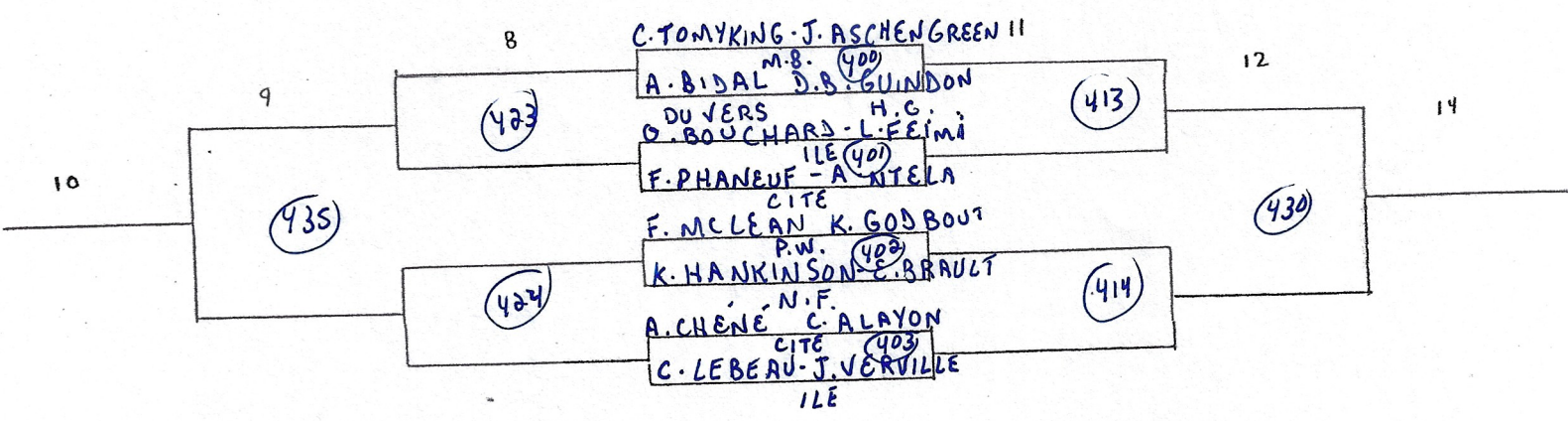
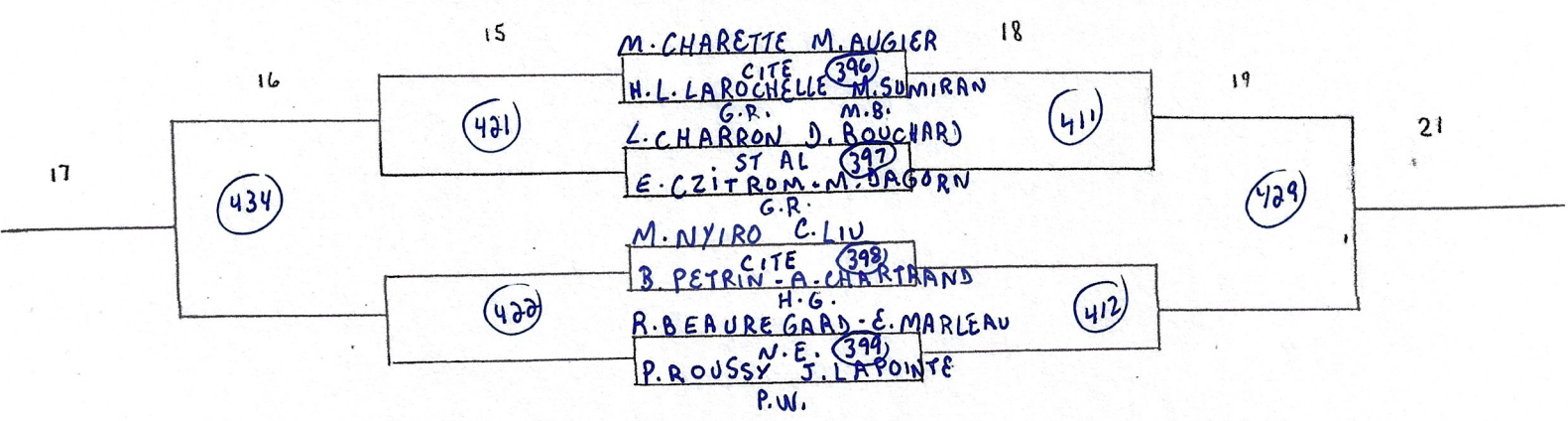

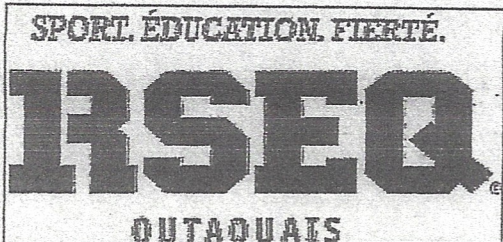

CATÉGORIE: DOUBLE MIXTE CADET

ÉCOLE: G. R.

HEURE: 14h45

POINTAGE: 1 MATCH 21 PTS
SANS PROL

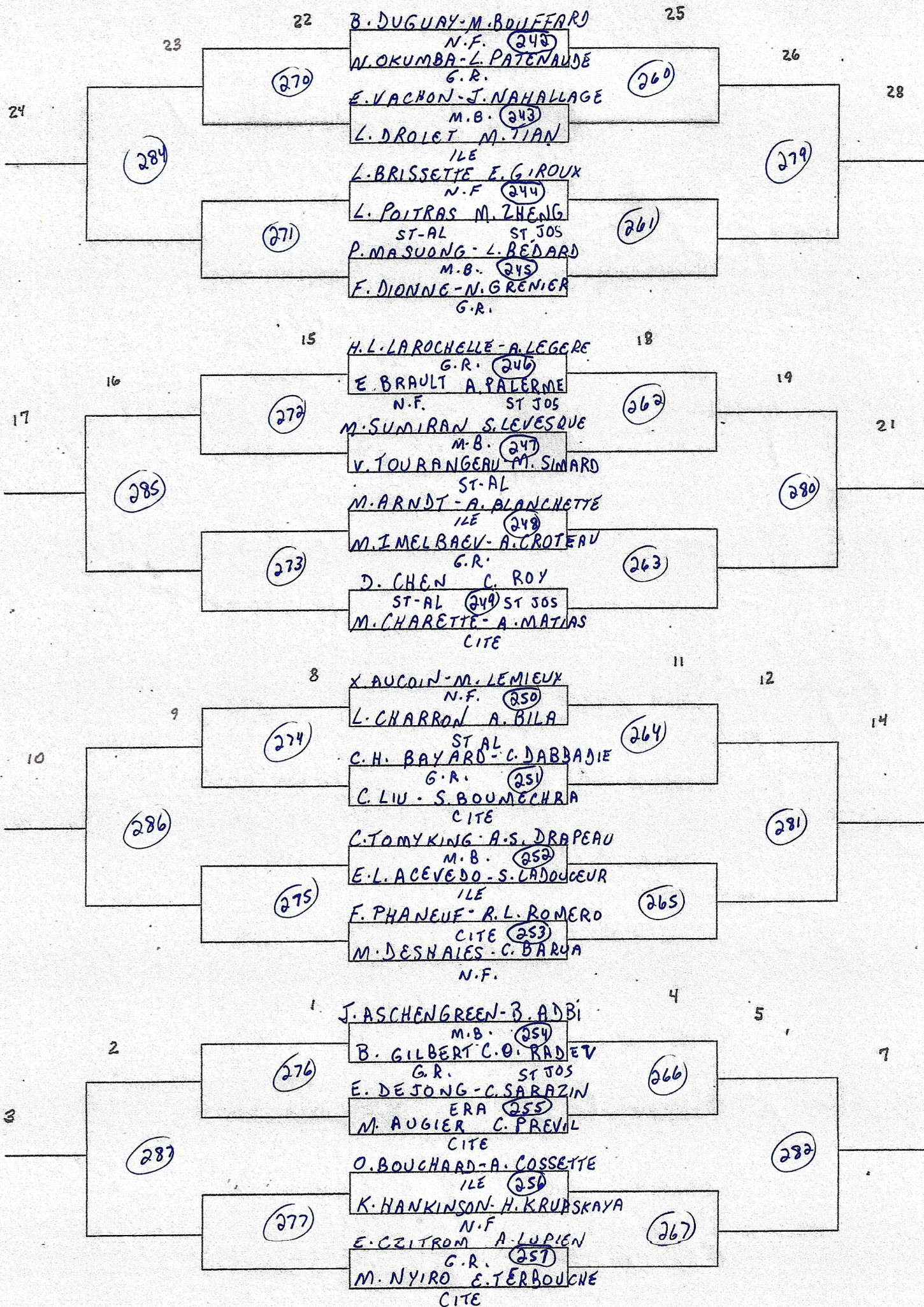

GRANDE RIVIÈRE
16 h

SIMPLE MASCULIN CADET
1 MATCH 21 PTS SANS PROL

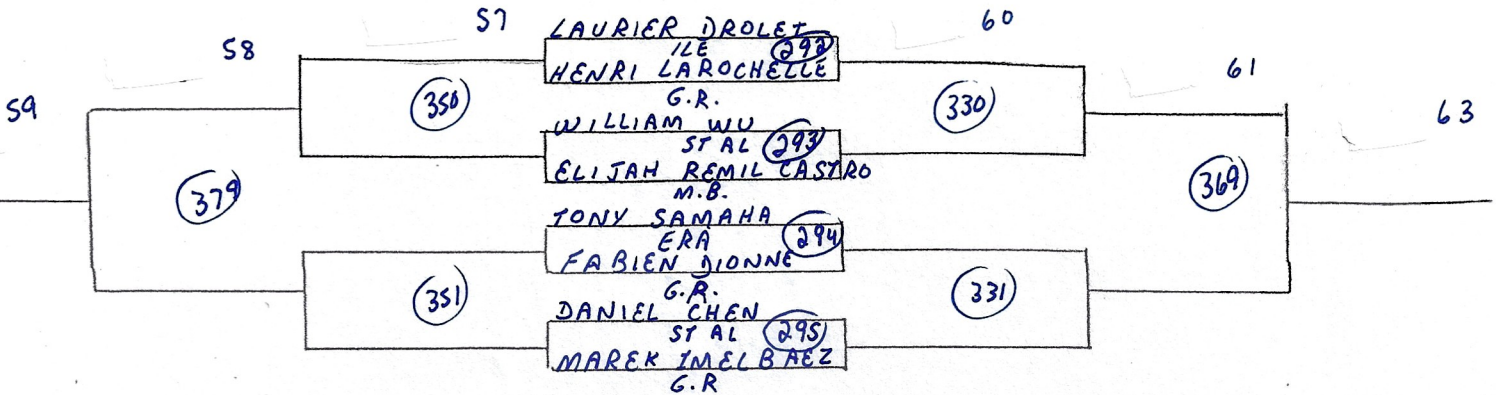
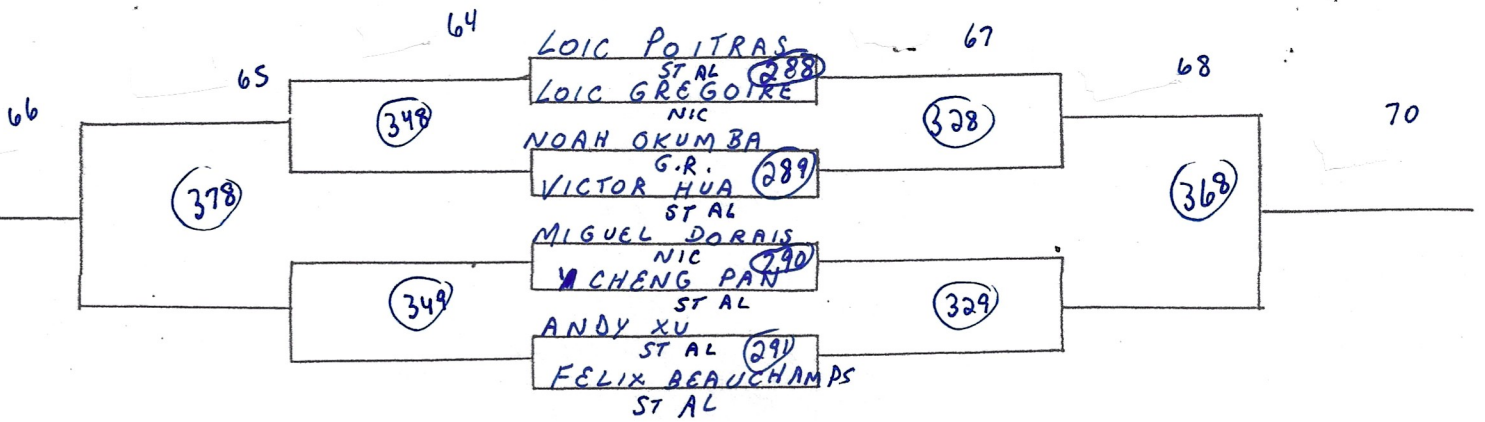

TOUS LES JOUEURS DOIVENT JOUER UN MINIMUM DE DEUX PARTIES PAR ÉPREUVE

